



# Split System Cooling Product Data

---

**XR17  
4TTR7**

**2, 3, 4 & 5 Tons**

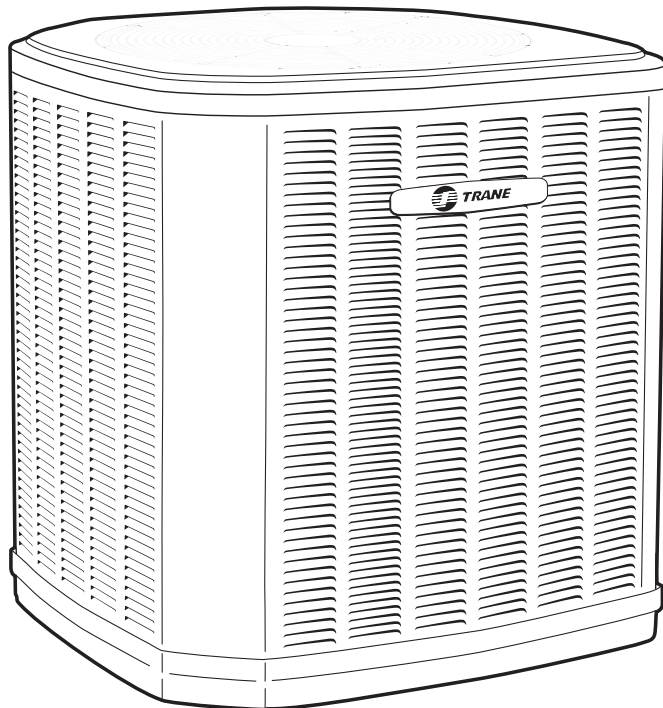

---

**PUB. NO. 22-1884-02**



# Features and Benefits

---

- **CLIMATUFF™** 2-stage scroll compressor
- Efficiency up to **18.0 SEER**
- All Aluminum **SPINE FIN™** coil
- **DURATUFF™** weather proof and rust proof base
- **COMFORT "R"™** mode approved for better comfort indoors
- **QUICK-SESS™** cabinet, service access and refrigerant connections with full coil protection
- **WEATHERGUARD™** fasteners
- Glossy corrosion resistant finish tarpaulin gray cabinet with anthracite gray top
- Internal compressor high/low pressure & temperature protection
- Liquid line filter/drier
- Low sound with advanced PSC fan motor
- Service valve cover
- R-410A refrigerant
- From 70 to 100% capacity modulation
- 100% run test in the factory
- Low ambient cooling to 55° as shipped
- **Extended warranties available**

# Contents

---

<b>Features and Benefits</b>	<b>2</b>
<b>General Data</b>	<b>4</b>
Product Specifications	4
A-weighted Sound Power Level [dB(A)]	4
Accessory Description and Usage	5
AHRI Standard Capacity Rating Conditions	5
<b>Model Nomenclature</b>	<b>6</b>
<b>Electrical Data</b>	<b>7</b>
<b>Dimensions</b>	<b>8</b>
<b>Mechanical Specifications</b>	<b>9</b>



# General Data

## Product Specifications

Model No. ①	4TTR7024A1000B	4TTR7036A1000B	4TTR7048A1000A	4TTR7060A1000A
Electrical Data V/Ph/Hz ②	208/230/1/60	208/230/1/60	208/230/1/60	208/230/1/60
Min Cir Ampacity	18	24	28	41
Max Fuse Size (Amps)	20	35	45	60
Compressor	CLIMATUFF® - SCROLL	CLIMATUFF® - SCROLL	CLIMATUFF® - SCROLL	CLIMATUFF® - SCROLL
No. Compress. – No. Stages	1 -2	1-2	1-2	1-2
RL AMPS - LR AMPS	13.0 - 52	17.0 - 82	21.2 - 104	32.1 - 152.9
Outdoor Fan FL Amps	0.74	0.74	1.00	1.30
Fan HP	1/8	1/8	1/5	1/4
Fan Dia (inches)	27.6	27.6	27.6	27.6
Coil	Spine Fin™	Spine Fin™	Spine Fin™	Spine Fin™
Refrigerant R-410A	9/13-LB/OZ	9/13-LB/OZ	12/9-LB/OZ	12/9-LB/OZ
Line Size - (in.) O.D. Gas ③	5/8	3/4	7/8	1-1/8
Line Size - (in.) O.D. Liquid ③	3/8	3/8	3/8	3/8
Dimensions H x W x D (Crated)	46.4 x 35.1 x 38.7	51.0 x 35.1 x 38.7	51.0 x 35.1 x 38.7	51.0 x 35.1 x 38.7
Weight - Shipping	276	283	308	312
Weight - Net	240	245	271	275
Start Components	NO	NO	NO	NO
Sound Enclosure	NO	NO	NO	NO
Compressor Sump Heat	NO	NO	NO	NO
<b>Optional Accessories: ④</b>				
Rubber Isolator Kit	BAYISLT101	BAYISLT101	BAYISLT101	BAYISLT101
Snow Leg - Base & Cap 4" High	BAYLEGS002	BAYLEGS002	BAYLEGS002	BAYLEGS002
Snow Leg - 4" Extension	BAYLEGS003	BAYLEGS003	BAYLEGS003	BAYLEGS003
Hard Start Kit Scroll	BAYKSKT263	BAYKSKT263	BAYKSKT266	BAYKSKT266
Crankcase Heater Kit	BAYCCHT301	BAYCCHT301	BAYCCHT301	BAYCCHT301
Extreme Condition Mounting Kit	BAYECMT004	BAYECMT004	BAYECMT004	BAYECMT004
Vertical Discharge Air Kit Base 4	BAYVDTA003	BAYVDTA004	BAYVDTA004	BAYVDTA004
Auto Charge Solenoid Kit	BAYCAKT001	BAYCAKT001	BAYCAKT001	BAYCAKT001
Refrigerant Lineset ⑤	TAYREFLN9*	TAYREFLN7*	TAYREFLN3*	TAYREFLN4*

① Certified in accordance with the Air-Source Unitary Heat Pump Equipment certification program which is based on AHRI Standard 210/240.

② Calculated in accordance with N.E.C. Only use HACR circuit breakers or fuses.

③ Standard line lengths - 60'. Standard lift - 25' Suction and Liquid line.

For Greater lengths and lifts refer to refrigerant piping software Pub# 32-3312-0\*. (\*denotes latest revision)

④ For accessory description and usage, see page 5.

⑤ \* = 15, 20, 25, 30, 40 and 50 foot lineset available.

## Sound Power Level

Model	A-Weighted Sound Power Level [dB(A)]	Full Octave Sound Power [dB]							
		63 Hz	125 Hz	250 Hz	500 Hz	1000 Hz	2000 Hz	4000 Hz	8000 Hz
4TTR7024A1	72	70	69	63	66	60	56	53	48
4TTR7036A1	72	64	67	65	64	60	56	54	50
4TTR7048A1	73	70	67	68	66	63	56	53	49
4TTR7060A1	74	68	70	66	69	66	57	57	53

Note: Rated in accordance with AHRI Standard 270-2008

# General Data

---

## Accessory Description and Usage

**Rubber Isolators** — 5 rubber donuts to isolate condensing unit from mounting frame or pad. Use on any application where sound transmission needs to be minimized.

**Extreme Conditions Mounting Kit** — Bracket kits to securely mount condensing unit to a frame or pad without removing any panels. Use in areas with high winds, or on commercial rooftops, etc.

**Low Ambient Cooling** — For low ambient cooling below 55° see Application Guide APP-APG013-EN.

## AHRI Standard Capacity Rating Conditions

### AHRI STANDARD 210/240 RATING CONDITIONS —

- (A) Cooling 80°F DB, 67°F WB air entering indoor coil, 95°F DB air entering outdoor coil.
- (B) High Temperature Heating 47°F DB, 43°F WB air entering outdoor coil, 70°F DB air entering indoor coil.
- (C) Low Temperature Heating 17°F DB, 15°F WB air entering outdoor coil, 70°F DB air entering indoor coil.
- (D) Rated indoor airflow for heating is the same as for cooling.

**AHRI STANDARD 270 RATING CONDITIONS** — (Noise rating numbers are determined with the unit in cooling operation.) Standard Noise Rating number is at 95°F outdoor air.





# Model Nomenclature

## Outdoor Units

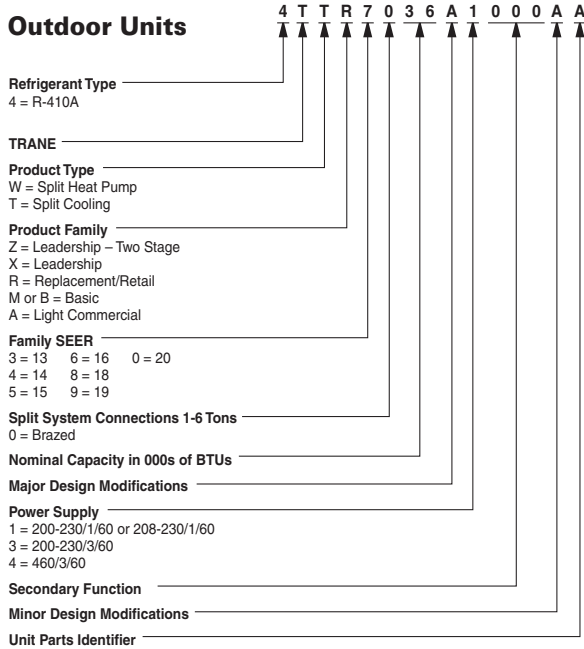

## Gas Furnaces

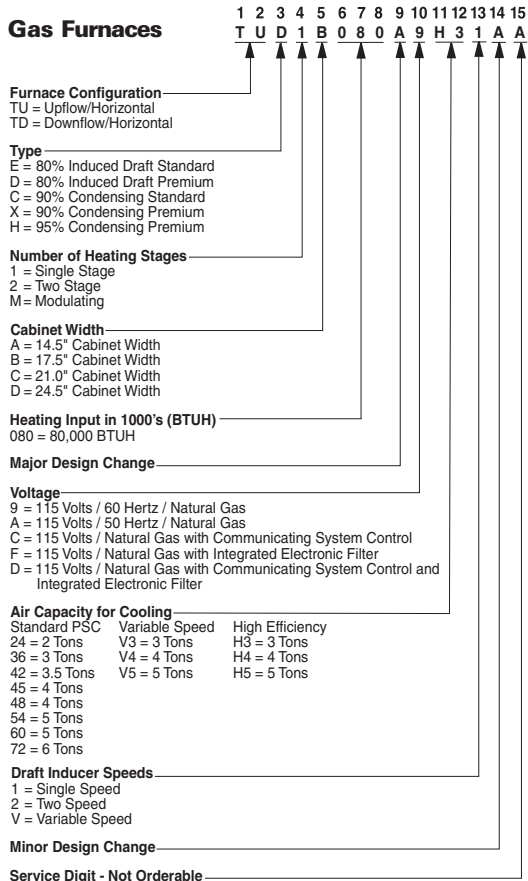

## Air Handler

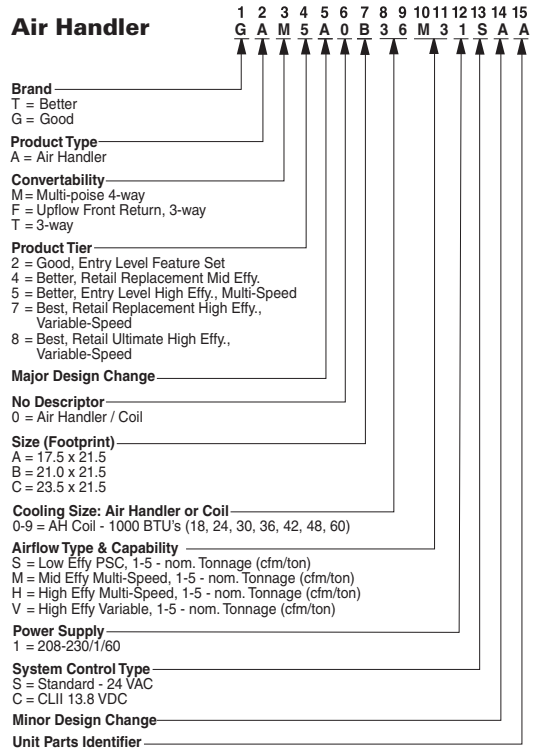

## Heat Pump/ Cooling Coils

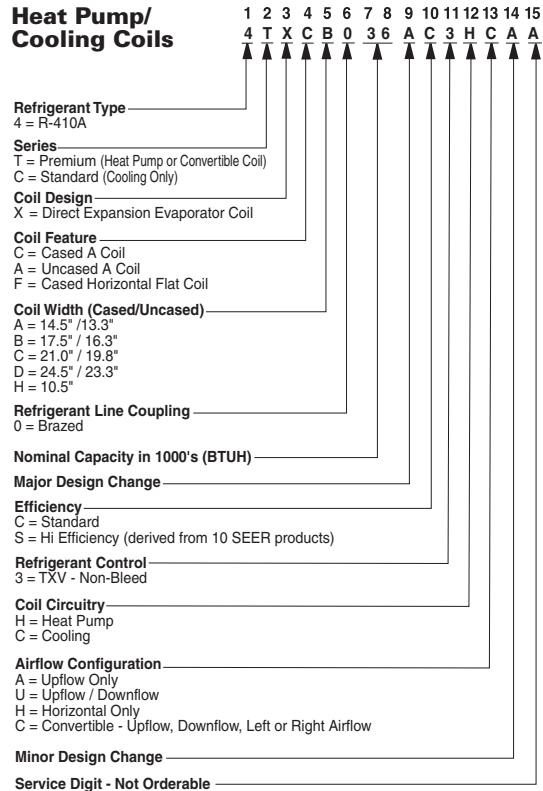

# Electrical Data

## Schematic Diagrams

(SEE LEGEND)

### 4TTR7024A, 036A

TO POWER SUPPLY PER UNIT NAMEPLATE AND LOCAL CODES

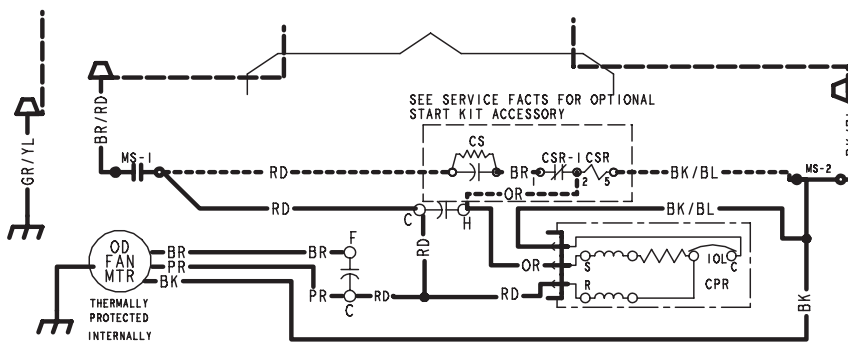

- ACR A/C RECTIFIER
- CF FAN CAPACITOR
- CN WIRECONNECTOR
- CPR COMPRESSOR
- CR RUN CAPACITOR
- CS STARTING CAPACITOR
- CSR CAPACITOR SWITCHING RELAY
- F INDOOR FAN RELAY
- HPCO HIGH PRESSURE CUTOUT SWITCH
- IOL INTERNAL OVERLOAD PROTECTOR
- LPCO LOW PRESSURE CUTOUT SWITCH
- SM SYSTEM ON-OFF SWITCH
- MS COMPRESSOR MOTOR CONTACTOR
- ODA OUTDOOR ANTICIPATOR
- OFT OUTDOOR FAN THERMOSTAT
- ODS OUTDOOR TEMPERATURE SENSOR
- ODT OUTDOOR THERMOSTAT
- SC SWITCH OVER VALVE SOLENOID
- TDL DISCHARGE LINE THERMOSTAT
- TDR TIME DELAY RELAY(5 SEC DELAY ON)
- TNS TRANSFORMER

COLOR OF WIRE  
 BK/BL  
 COLOR OF MARKER

- BK BLACK RD RED OR ORANGE
- BL BLUE WH WHITE GR GREEN
- BR BROWN YL YELLOW PR PURPLE
- PK PINK

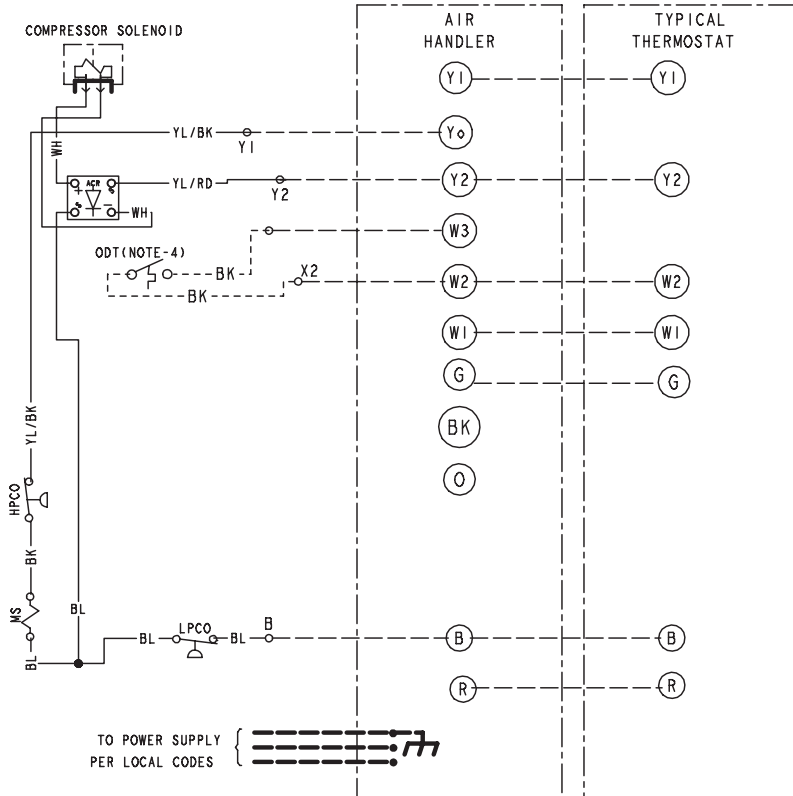

#### WARNING

HAZARDOUS VOLTAGE!  
 DISCONNECT ALL ELECTRICAL POWER INCLUDING REMOTE DISCONNECTS BEFORE SERVICING.  
 Failure to disconnect power before servicing can cause severe personal injury or death.

#### CAUTION

USE COPPER CONDUCTORS ONLY!  
 UNIT TERMINALS ARE NOT DESIGNED TO ACCEPT OTHER TYPES OF CONDUCTORS.  
 Failure to do so may cause damage to the equipment.

- NOTES:
1. BE SURE POWER SUPPLY AGREES WITH EQUIPMENT NAMEPLATE.
  2. POWER WIRING AND GROUNDING OF EQUIPMENT MUST COMPLY WITH LOCAL CODES.
  3. LOW VOLTAGE WIRING MUST BE 18 AWG MINIMUM CONDUCTOR.
  4. IF OUTDOOR THERMOSTAT IS NOT USED, CONNECT W2 TO W3.
  5. WITH Y1 ENERGIZED, INDOOR FAN IS 1ST STAGE AIRFLOW.
  6. WITH Y1 & Y2 ENERGIZED, INDOOR FAN IS 2ND STAGE AIRFLOW.
  7. SEE AIR HANDLER INSTALLER GUIDE FOR DIP SWITCH CONFIGURATIONS.

FOR CANADIAN INSTALLATIONS  
 POUR INSTALLATIONS CANADIENNES

CAUTION: NOT SUITABLE FOR USE ON SYSTEMS EXCEEDING 150V-TO-GROUND  
 ATTENTION: NE CONVIENT PAS AUX INSTALLATIONS DE PLUS DE 150 V A LA TERRE



# Electrical Data

## Schematic Diagrams

(SEE LEGEND)

### 4TTR7048A, 060A

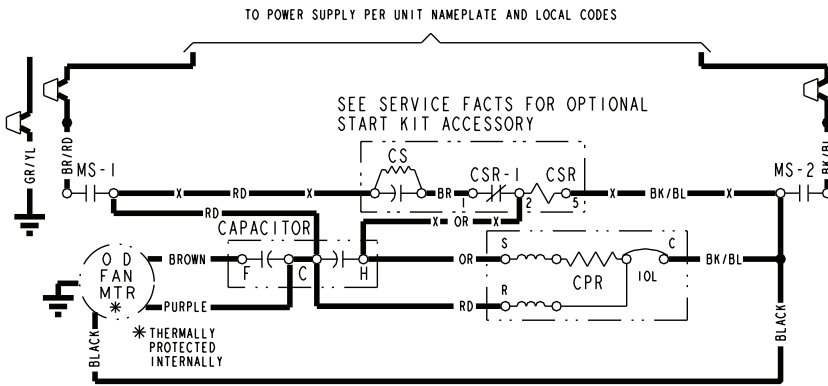

CA	COOLING ANTICIPATOR	LPCO	LOW PRESSURE CUTOFF SW.
CBS	COIL BOTTOM SENSOR	MS	COMPRESSOR MOTOR CONTACTOR
CF	FAN CAPACITOR	ODA	OUTDOOR ANTICIPATOR
CN	WIRE CONNECTOR	OFT	OUTDOOR FAN THERMOSTAT
CPR	COMPRESSOR RUN CAPACITOR	ODS	OUTDOOR TEMPERATURE SENSOR
CS	STARTING CAPACITOR	ODT	OUTDOOR THERMOSTAT
CSR	CAPACITOR SWITCHING RELAY	RHS	RESISTANCE HEAT SWITCH
DFC	DEFROST CONTROL	SC	SWITCHOVER VALVE SOLENOID
F	INDOOR FAN RELAY	SM	SYSTEM "ON-OFF" SWITCH
HA	HEATING ANTICIPATOR	TDL	DISCHARGE LINE THERMOSTAT
HPCO	HIGH PRESSURE CUTOFF SW.	TDR	TIME DELAY RELAY (5 SEC DELAY ON)
IOL	INTERNAL OVERLOAD PROTECTOR	TNS	TRANSFORMER
ACR	A/C RECTIFIER	TSH	HEATING-COOLING THERMOSTAT

<p><b>⚠ WARNING</b> HAZARDOUS VOLTAGE! DISCONNECT ALL ELECTRIC POWER INCLUDING REMOTE DISCONNECTS BEFORE SERVICING. FAILURE TO DISCONNECT POWER BEFORE SERVICING CAN CAUSE SEVERE PERSONAL INJURY OR DEATH!</p>	<p><b>⚠ CAUTION</b> USE COPPER CONDUCTORS ONLY! UNIT TERMINALS ARE NOT DESIGNED TO ACCEPT OTHER TYPES OF CONDUCTORS. FAILURE TO DO SO MAY CAUSE DAMAGE TO THE EQUIPMENT!</p>
---	--

COLOR OF WIRE

BK/BL BLACK WIRE WITH BLUE MARKER

COLOR OF MARKER

BK	BLACK	OR	ORANGE	YL	YELLOW
BL	BLUE	RD	RED	GR	GREEN
BR	BROWN	WH	WHITE	PR	PURPLE

**NOTES:**

1. BE SURE POWER SUPPLY AGREES WITH EQUIPMENT NAMEPLATE.
2. POWER WIRING AND GROUNDING OF EQUIPMENT MUST COMPLY WITH LOCAL CODES.
3. LOW VOLTAGE WIRING TO BE NO. 18 AWG MINIMUM CONDUCTOR.
4. IF OUTDOOR THERMOSTAT (ODT) IS NOT USED, CONNECT W2 TO W3.
5. WITH Y1 ENERGIZED, INDOOR FAN IS 1ST STAGE AIRFLOW.
6. WITH Y1 & Y2 ENERGIZED, INDOOR FAN IS 2ND STAGE AIRFLOW.
7. SEE AIR HANDLER INSTALLER GUIDE FOR DIP SWITCH CONFIGURATIONS.

FOR CANADIAN INSTALLATIONS  
POUR INSTALLATIONS CANADIENNES

**CAUTION:** NOT SUITABLE FOR USE ON SYSTEMS EXCEEDING 150V-TO-GROUND.  
**ATTENTION:** NE CONVIENT PAS AUX INSTALLATIONS DE PLUS DE 150 V A LA TERRE.

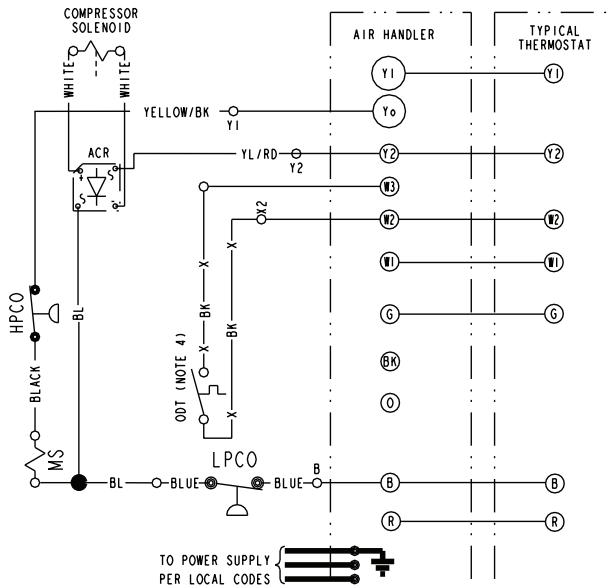

























# Electrical Data

## Schematic Diagrams

### LEGEND

 COLOR OF WIRE BK/BL BLACK WIRE WITH BLUE MARKER  COLOR OF MARKER					
BK	BLACK	OR	ORANGE	YL	YELLOW
BL	BLUE	RD	RED	GR	GREEN
BR	BROWN	WH	WHITE	PR	PURPLE

	24 V.	}	FACTORY WIRING
	LINE V.		
	24 V.	}	FIELD WIRING
	LINE V.		
	FIELD INSTALLED FACTORY WIRING		
	GROUND		
	JUNCTION		
	WIRE NUT OR CONNECTOR		
	COIL		
	CAPACITOR		
	RELAY CONTACT (N.O.)		
	RELAY CONTACT (N.C.)		
	THERMISTOR		
	INTERNAL OVERLOAD PROTECTOR		
	PRESSURE ACTUATED SWITCH		
	TEMP. ACTUATED SWITCH		
	POL. PLUG FEMALE HOUSING (MALE TERM.)		
	POL. PLUG MALE HOUSING (FEMALE TERM.)		
	RESISTOR OR HEATING ELEMENT		
	MOTOR WINDING		
	TERMINAL		

CA	COOLING ANTICIPATOR	LPCO	LOW PRESSURE CUTOUT SW.
CBS	COIL BOTTOM SENSOR	MS	COMPRESSOR MOTOR CONTACTOR
CF	FAN CAPACITOR	ODA	OUTDOOR ANTICIPATOR
CN	WIRE CONNECTOR	OFT	OUTDOOR FAN THERMOSTAT
CPR	COMPRESSOR	ODS	OUTDOOR TEMPERATURE SENSOR
CR	RUN CAPACITOR	ODT	OUTDOOR THERMOSTAT
CS	STARTING CAPACITOR	RHS	RESISTANCE HEAT SWITCH
CSR	CAPACITOR SWITCHING RELAY	SC	SWITCHOVER VALVE SOLENOID
DFC	DEFROST CONTROL	SM	SYSTEM "ON-OFF" SWITCH
F	INDOOR FAN RELAY	TDL	DISCHARGE LINE THERMOSTAT
HA	HEATING ANTICIPATOR	TNS	TRANSFORMER
HPCO	HIGH PRESSURE CUTOUT SW.	TS	HEATING-COOLING THERMOSTAT
IOL	INTERNAL OVERLOAD PROTECTOR	TSH	HEATING THERMOSTAT



# Dimensions

## 4TTR7 Outline Drawing

Note: All dimensions are in MM (Inches).

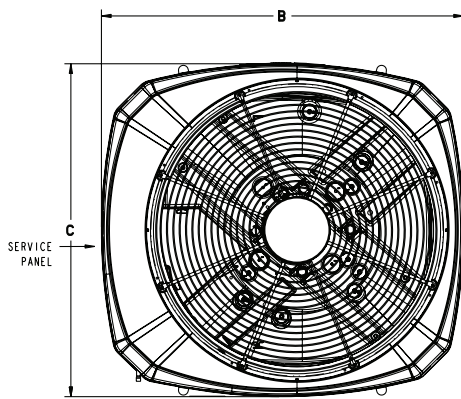

TOP DISCHARGE AREA SHOULD BE UNRESTRICTED FOR AT LEAST 1524 (5 FEET) ABOVE UNIT. UNIT SHOULD BE PLACED SO ROOF RUN-OFF WATER DOES NOT POUR DIRECTLY ON UNIT, AND SHOULD BE AT LEAST 305 (12") FROM WALL AND ALL SURROUNDING SHRUBBERY ON TWO SIDES. OTHER TWO SIDES UNRESTRICTED.

ELECTRICAL AND REFRIGERANT COMPONENT CLEARANCES PER PREVAILING CODES.

FIG. 1

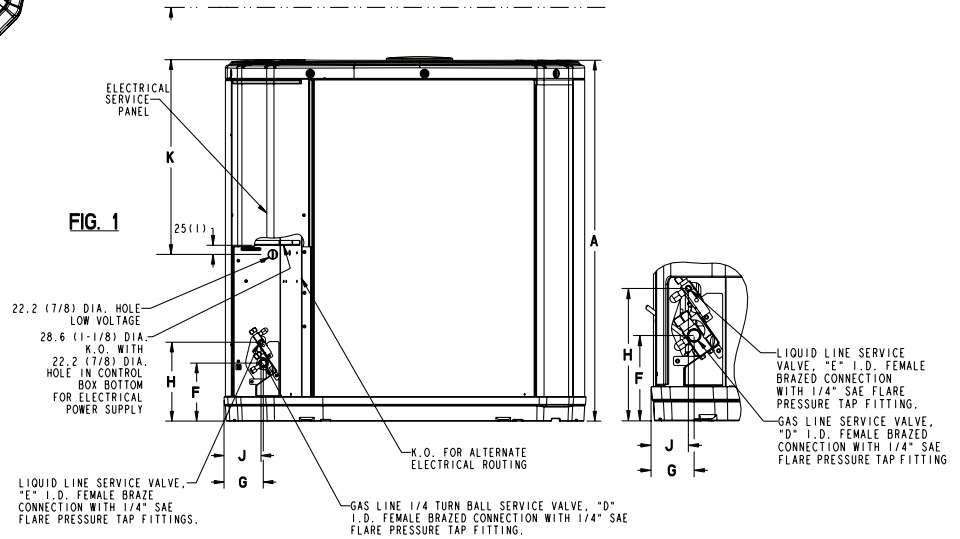

MODELS	BASE	A	B	C	D	E	F	G	H	J	K
4TTR7024A	4	1045 (41 1/8)	946 (37-1/4)	870 (34-1/4)	5/8	3/8	152 (6)	98 (3-7/8)	219 (8-5/8)	86 (3-3/8)	711 (28)
4TTR7036A	4	1147 (45 1/8)	946 (37-1/4)	870 (34-1/4)	3/4	3/8	152 (6)	98 (3-7/8)	219 (8-5/8)	86 (3-3/8)	813 (32)
4TTR7048A	4	1147 (45 1/8)	946 (37-1/4)	870 (34-1/4)	7/8	3/8	152 (6)	98 (3-7/8)	219 (8-5/8)	86 (3-3/8)	813 (32)
4TTR7060A	4	1147 (45 1/8)	946 (37-1/4)	870 (34-1/4)	1-1/8	3/8	152 (6)	98 (3-7/8)	219 (8-5/8)	86 (3-3/8)	813 (32)

From Dwg. D152635



# Mechanical Specifications

## General

The 4TTR7 is fully charged from the factory for matched indoor section and up to 15 feet of piping. This unit is designed to operate at outdoor ambient temperatures as high as 115°F. Cooling capacities are matched with a wide selection of air handlers and furnace coils that are AHRI certified. The unit shall be certified to UL 1995. Exterior is designed for outdoor application.

## Casing

Unit casing is constructed of heavy gauge, G60 galvanized steel and painted with a weather-resistant powder paint on all louvers and panels. Corrosion and weatherproof CMBP-G30 DuraTuff™ base.

## Refrigerant Controls

Refrigeration system controls include condenser fan, compressor contactor and high pressure switch. High and low pressure controls are inherent to the compressor. A factory installed liquid line drier is standard.

## Compressor

The Climatuff® 2-stage compressor features internal over temperature and pressure protection and hermetic motor. Other features include: centrifugal oil pump and modular plugs for electrical connections.

## Condenser Coil

The outdoor coil provides low airflow resistance and efficient heat transfer. The coil is protected on all four sides by louvered panels.

## Low Ambient Cooling

As manufactured, this unit has a cooling capability to 55°F. For low ambient cooling below 55° see Application Guide.





Trane  
[www.trane.com](http://www.trane.com)

---

---

---

08/14

*Trane has a policy of continuous product and product data improvement and it reserves the right to change design and specifications without notice.*